

LED High Bay Light - HB3200



I. Application

Workshop, warehouse, highway toll stations, gas stations, supermarkets, Exhibition halls, stadiums, etc.

II. Features

1. Applying heat pipe technology to obtain higher efficiency of heat dissipation, lighter of aluminum housing.
2. Design of module aluminum housing can improve horizontal heat convection to prevent driver casing overheating and protect the driver working under normal temperature.
3. LED chip options: BridgeLux / CREE / PHILIPS.
4. Offering three or five years of warranty .

LED High Bay Light - HB3200

III. Drawing

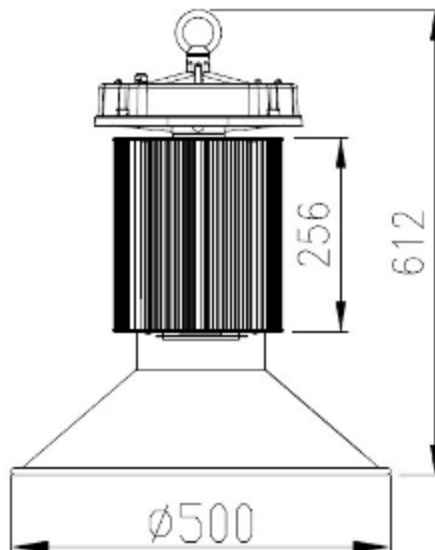
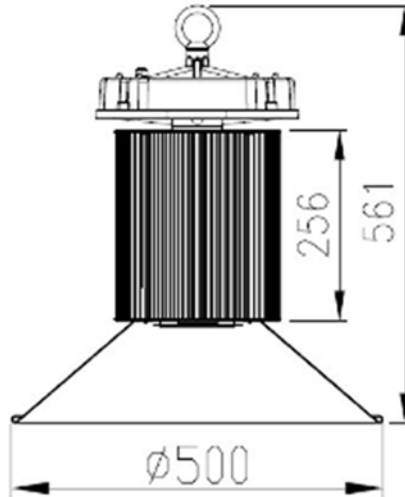
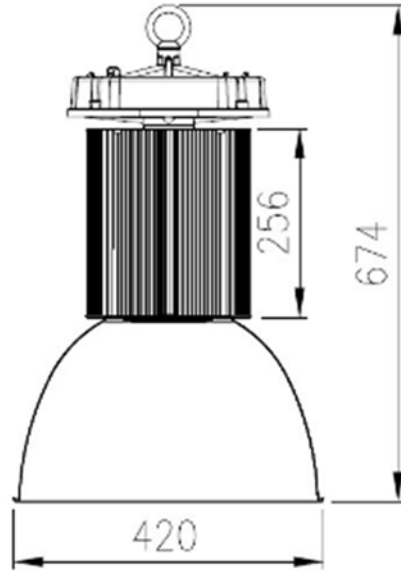

LED High Bay Light - HB3200

IV. Technical Parameter

Item No.	Input Voltage	Power	Beam Angle	CRI	Lumens
HB3200-D45	AC100V-277V	210W	45°	Ra≥70	17600 LM
HB3200-D90	AC100V-277V	210W	90°	Ra≥70	18200 LM
HB3200-D120	AC100V-277V	210W	120°	Ra≥70	19000 LM
BridgeLux / CREE / PHILIPS					
CCT: 3000K/4000K/5000K/6000K					
Driver Efficiency >0.9					
PF>0.95					
Working Ambient Temperature: -40°C ~ 45°C					
Storage Temperature : -40°C ~ 50°C					

V. Thermal Image

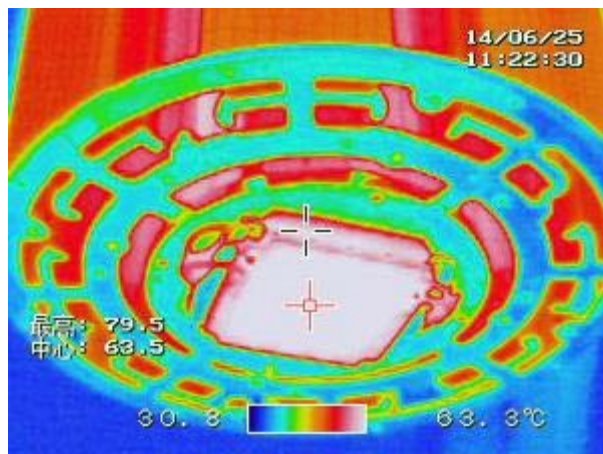
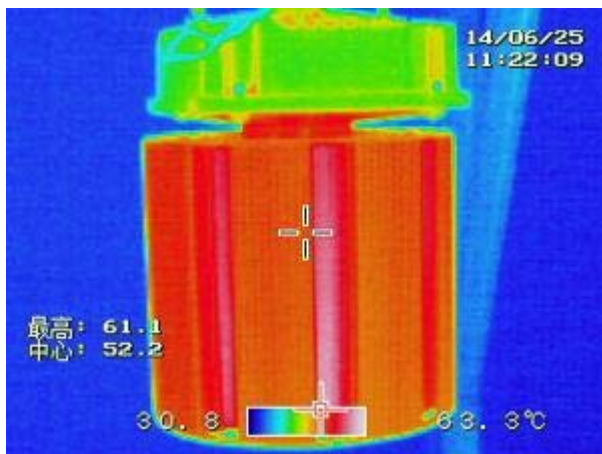

LED High Bay Light - HB3200

VI. Distribution Curve

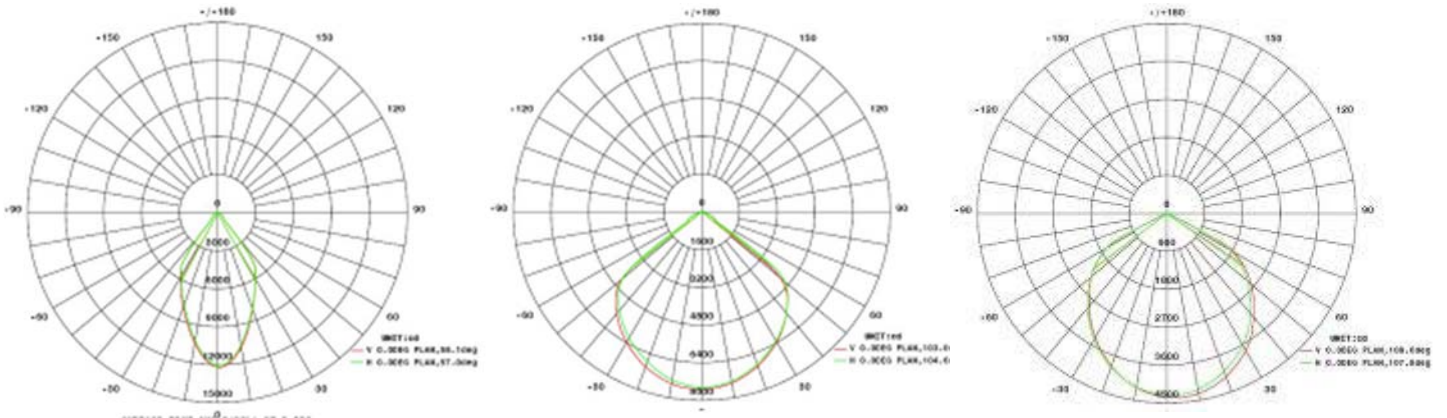

VII. Installation Instruction

1

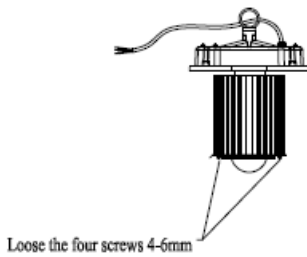

2

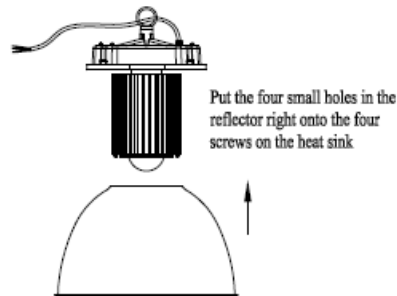

3

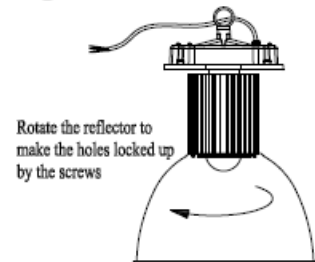

4

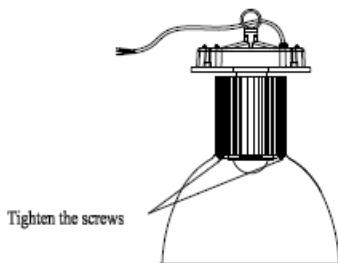

5

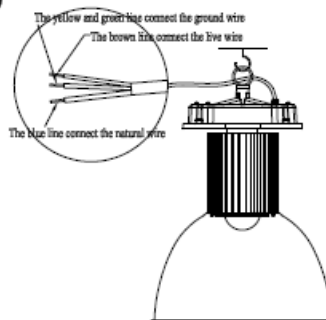

LED High Bay Light - HB3200

Installation Caution

1. Before maintenance, please ensure the light have been powered off.
2. Make sure the installation position can bear the weight of the luminaire.
3. Clean the lens cover regularly to maintain high transmission of light.
4. Clean up the dust from the reflector and heat sink regularly to keep sound heat dissipation.
5. Don't use water or corrosive solution for cleaning, preferably with a dry cloth.
6. When install or replace power supply, directly open the back cover with a screwdriver, then remove the power supply. There is a three-core cable of AC power, red corre-

VIII. Package

Lamp body

Item	Data
Carton	32*32*46 cm
Quantity	1pcs
N.W	6.6 kg
G.W.	7.6 kg

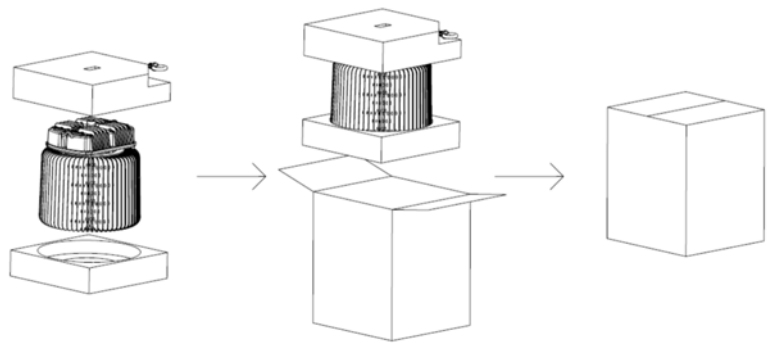

Reflectors

Item	45°	90°	120°
Carton	45*45*37cm	53*53*37cm	53*53*28cm
Quantity	10 pcs	7 pcs	20 pcs
G.W.	8 kg	6 kg	13 kg

